



WE MAKE WHAT MATTERS WORK

SmartWire-DT ile Akıllı Çekmeceli
xEnergy Pano Sistemi

Zafer Budak, Ulaş Cihangir
02.11.2023

EAT•N

Powering Business Worldwide

© 2021 Eaton. All rights reserved.

ETRAFINIZA BAKIN

Modern dünyamızda dokunduğumuz, yaptığımız veya gördüğümüz her şey **güç sayesinde mümkün** hale geliyor.

EAT•N

Powering Business Worldwide



İnsanların yaşamlarını ve çevreyi iyileştirmeye kendimizi adıyoruz.

Daha **güvenilir**, **verimli** ve **emniyetli** güç yönetimi teknolojileri sağlıyoruz.

EAT•N

Powering Business Worldwide

Eaton'ın Elektrik Sektörü: Küresel erişim, lokal derinlik

- 175'den fazla ülkede müşteriler
- Binlerce mühendis ve servis personeli
- 7,500'den fazla satış ve pazarlama profesyoneli
- 12,000'den fazla lokasyonda distribütörler

EAT•N

Powering Business Worldwide

Yönetim merkezi ve önemli lokasyonlar



- Yönetim Merkezi: Dublin, Ireland
- Yönetim Kurulu Bşk. & CEO – Craig Arnold
- Önemli lokasyonlar:

Cleveland, A.B.D.; Morges, İsviçre;
Shanghai, Çin; Sao Paulo, Brezilya

Elektrik Sektörü:
2021 Satış \$12,7 B

Endüstri Sektörü:
2021 Satış \$6,9 B

Toplam Satışlar:
\$19,6 Billion USD

Net Kâr:
\$2,1 Billion USD

METALUX MEM CUTLER-HAMMER COOPER
 COOPER HALO ARROW HART HOLEC METALUX
 B-LINE BUSSMANN MTL CEAG
 HOLEC MCGRAW-EDISON ARROW HART MOELLER
 ARROW HART MEM BUSSMANN HALO
 METALUX POWERWARE HERNIS B-LINE
 HALO MEM
 MCGRAW-EDISON
 MOELLER MTL
 CEAG COOPER
 MTL B-LINE
 HERNIS CEAG
 MCGRAW-EDISON B-LINE COOPER MTL
 MEM BUSSMANN CEAG HOLEC MOELLER
 ARROW HART MTL POWERWARE CEAG
 MOELLER COOPER MGE OFFICE PROTECTION SYSTEMS
 HALO MTL HERNIS POWERWARE
 MTL POWERWARE HALO CROUSE-HINDS
 COOPER BUSSMANN CEAG ARROW HART METALUX

MORE POSSIBILITIES.
 POWERFUL SOLUTIONS.

BRAND
 INCEPTION
 DATES:



Türkiye'de EATON

- 2008 - Türkiye pazarına Moeller satın almasıyla girdi
- 2012 - Polimer Kauçuk ve Cooper satın almalarıyla önemli ölçüde genişledi
 - Dünya'da alanındaki en büyük üretim tesisi, 100.000 m²
- 2019 - Ulusoy Elektrik satın alması ile konumunu güçlendirdi
- Bugün itibariyle;
 - 1.000'den fazla çalışan
 - Yurt içinde 700'den fazla müşteri

MOELLER



ULUSOY
electric

EATON

Powering Business Worldwide

Gündem

xEnergy Pano Sistemi
SmartWire-DT ile Akıllı MCC



Tip testli montaj	: IEC/EN 61439-2:2011
İç Ark Dayanımı	: IEC 61641 1-7. Kriter dahil
Deprem	: IEC 60068-3-3
Dahili bölümlendirme	: Form 1' den Form 4b' ye kadar
Anma çalışma gerilimi U_e	: 690V / 50 - 60Hz
Anma Akımı I_e	: 800-7100 A' e kadar
Kısa devre dayanımı I_{cw}	: 105 kA 1sn, 66kA 3sn.
Şebeke sistemi	: TN-C / TN-C-S / TN-S / IT
Sac kalınlığı	
Ön kapı, ana karkas	: 2 mm
Arka, yan kapaklar	: 1.5 mm
Montaj plakaları	: 2.5 mm
Koruma Sınıfı	: IP 31 / IP 41 / IP 42 / IP 55
Renk	: RAL 7035

Eaton

Ürünler
+
Dizayn
Doğrulama



- Panolar
- Ekipmanlar

Panel builder

Montaj Direktif ve Klavuzları

www.xenergy-partner.com

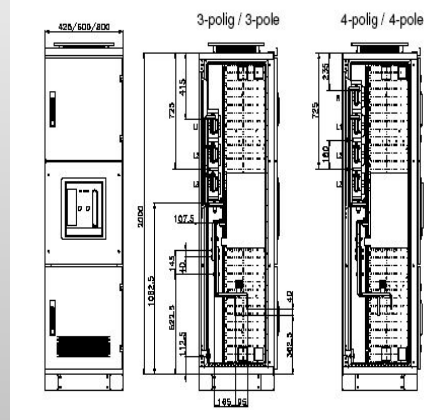

Montaj
+
Rutin testler



Customer



IEC /EN 61439



IMCC

xEnergy Pano Sistemi



XP Power sections



XF Outgoing sections
Fixed



XR Outgoing sections
Removable



XW Outgoing sections
Withdrawable
with SmartWire-DT
Communication



XG section



Powering Business Worldwide

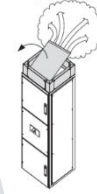
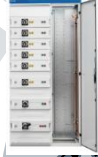



Üretim

- Çekmecelerin içinde maliyet ve zaman alıcı kontrol kablolama;
- Çekmecelerden PLC'ye kablolama;
- Çekmece ve bölümün zaman alıcı testleri;
- Genişlemerin gerçekleştirilmesi zorluğu.

İşlevsellik

- Haberleşme için artan gereksinimler;
- Daha fazla teşhis / işlem veri ihtiyacı
- İşletme kolaylığı.



- Çekmecenin içindeki SmartWire-DT, kontrol kablolarının yerini alır.
- SWD Assist kullanılarak PLC' ihtiyaç olmadan çekmece ünitelerinin hızlı testi
- Çekmeceler arasındaki iletişim de SmartWire-DT kullanılarak gerçekleştirilir.
- Çeşitli haberleşme arayüzü bağlantısı ile farklı PLC ürünlerine kolaylıkla haberleşme sağlar.
- Akıllı şalt cihazları ile erken aşırı yük bilgisi.
- Genişletilmiş teşhis bilgileri (Kısa devre, aşırı yük, faz kaybı....)
- Çekmece yeniden yapılandırma olmadan değiştirilebilir.

Akıllı MCC Sistemleri Uygulama Alanları

- Su Arıtma Tesisleri
- İlaç Sanayi
- Endüstriyel Tesisler
- Gıda Endüstrisi
- Kağıt Endüstrisi
- Maden Endüstrisi
- Metal Endüstrisi
- Otomotiv Endüstrisi



Gündem

xEnergy Pano Sistemi
SmartWire-DT ile Akıllı MCC

SmartWire-DT – Baęlanmanın en kolay yolu



Tanım:

SmartWire-DT, kontrol panosunun içindeki ve dışındaki endüstriyel şalt cihazlar için entegre haberleşmeli ve yalın bir kablolama sistemidir.

SmartWire-DT – Yalın Bağlantı Teknolojisi

Bu Yalın Çözüm Size Ne Fayda Sağlar?

- İmalat, mühendislik, devreye alma maliyetlerini azaltır
- Montaj, işletme ve bakım kolaylığı
- Bağlı cihazlardan daha fazla veri alınır

SmartWire-DT faydaları : Üretim, Devreye alma, İşletme

Geleneksel Pano



- Panolardaki kontrol kablolaması dizayn ve montaj için çok fazla efor gerektirir.
- Test ve devreye alma çok fazla zaman alıcıdır.
- Çalışma sırasında ek işlevleri eklemek çok zordur.



- Kontrol kablolarını kullanmaya gerek yok
- Daha az hata ile daha hızlı montaj
- Daha hızlı test ve daha hızlı devreye alma
- Daha kolay sorun giderme



SmartWire-DT – Yalın Mimari

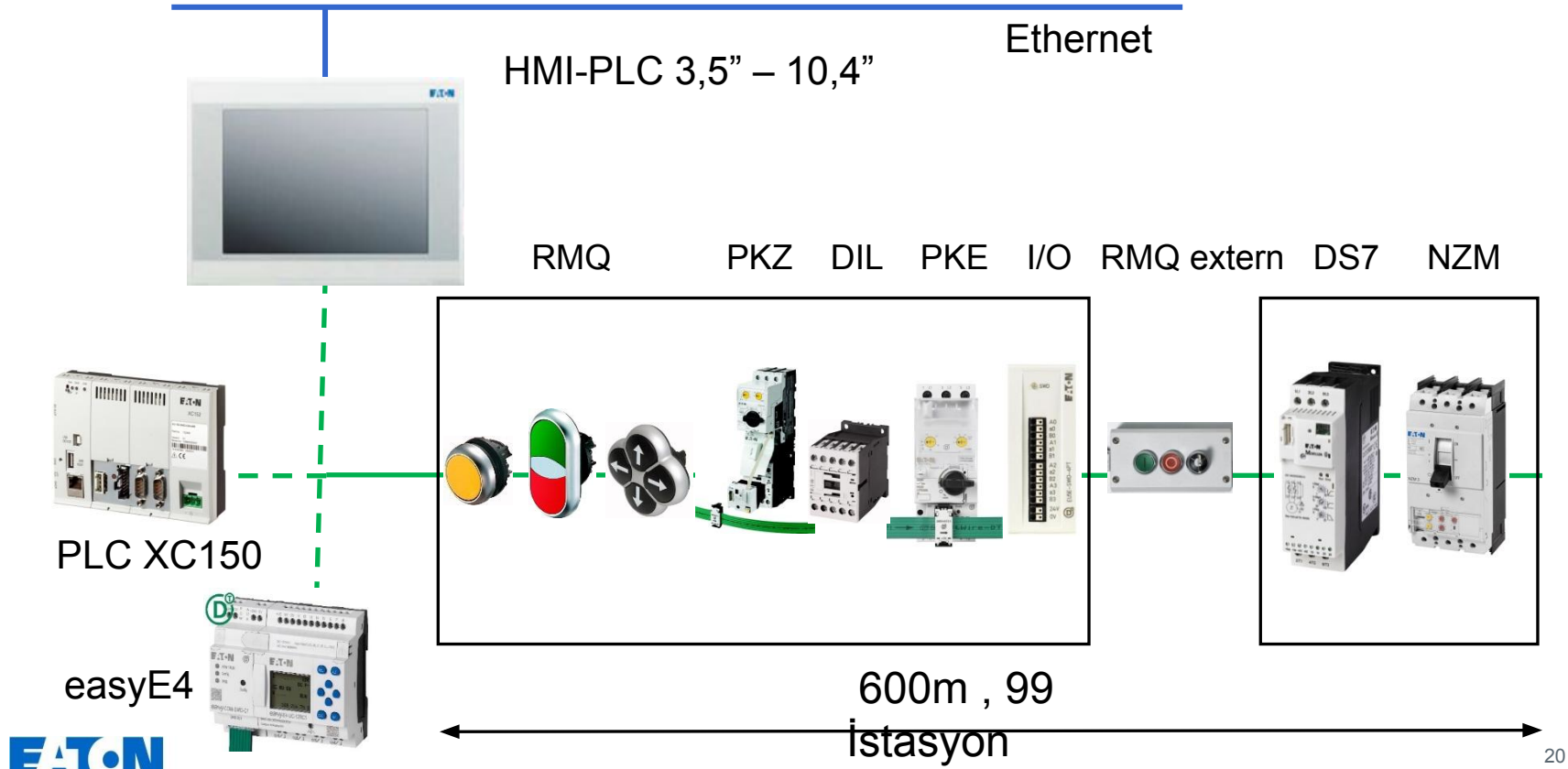

SmartWire-DT – Temel Mimari



PLC

Profibus
CANopen
Modbus-TCP
Ethernet/IP
Profinet
Powerlink
Ethercat

Fieldbus



SWD

RMQ

PKZ

DIL

PKE

I/O

harici RMQ

DS7

NZM

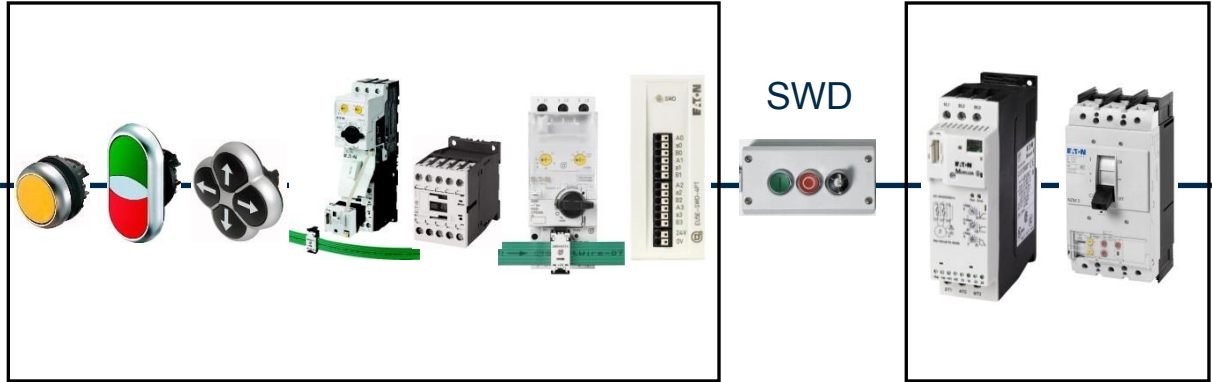

600m
99 istasyon

IoT Gereksinimleri

IoT
Gereksinim
Piramidi

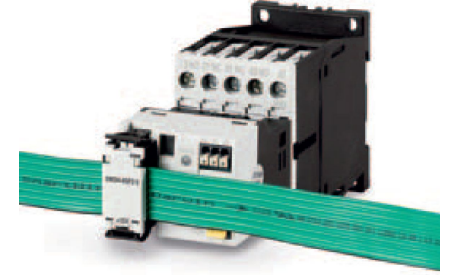
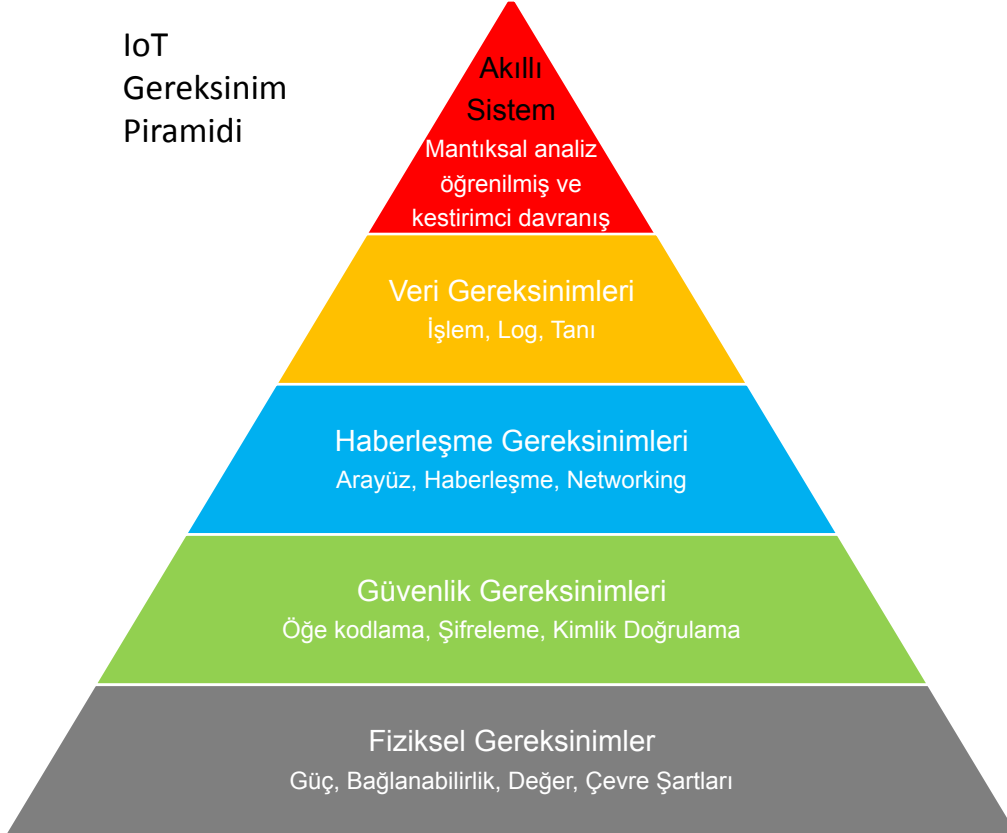

IoT Gereksinimleri

IoT
Gereksinim
Piramidi

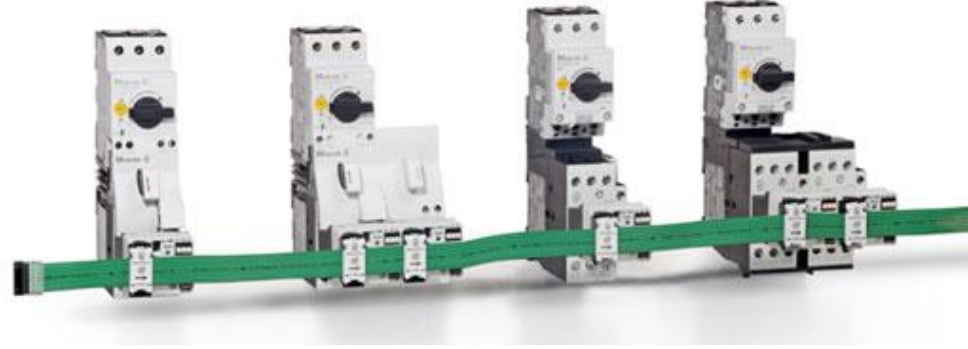
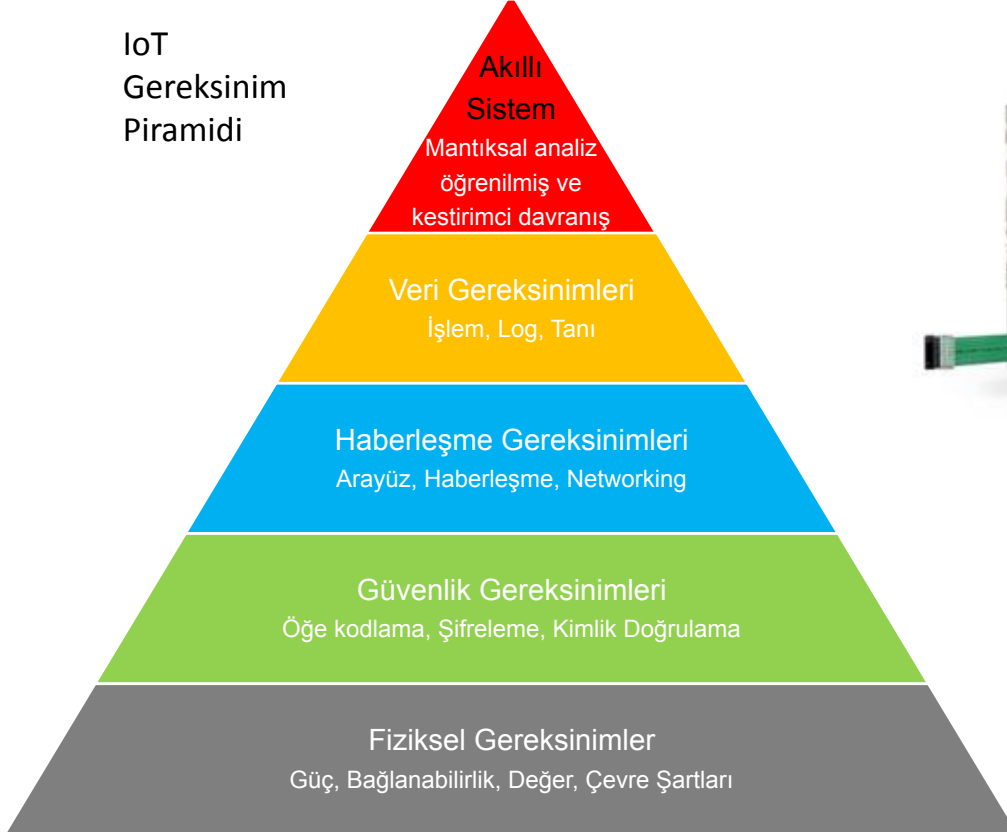

xEnergy iMCC Sistem Yapısı

Fieldbus (Profibus, CANopen, Ethernet/IP, Modbus-TCP, Profinet, Powerlink, Sercos, Ethercat ..)

PLC,
HMI-PLC

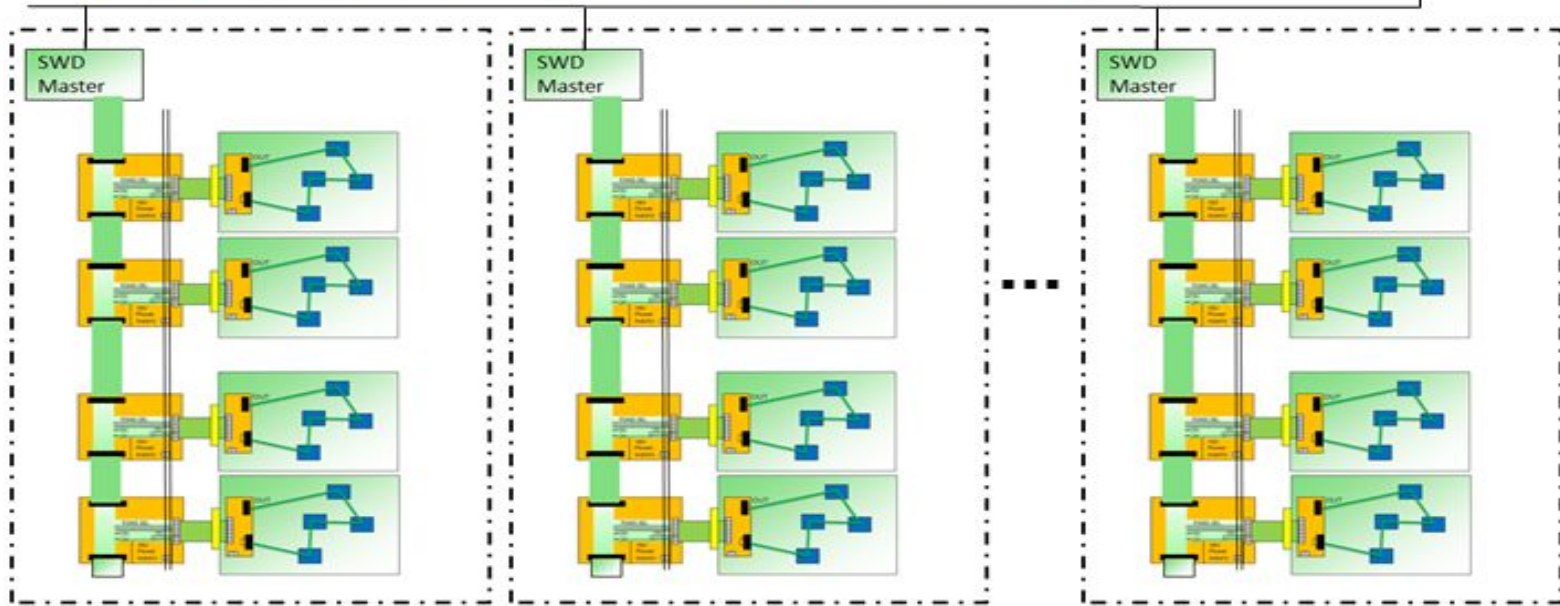
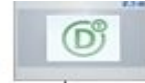

xEnergy iMCC Sistem Yapısı

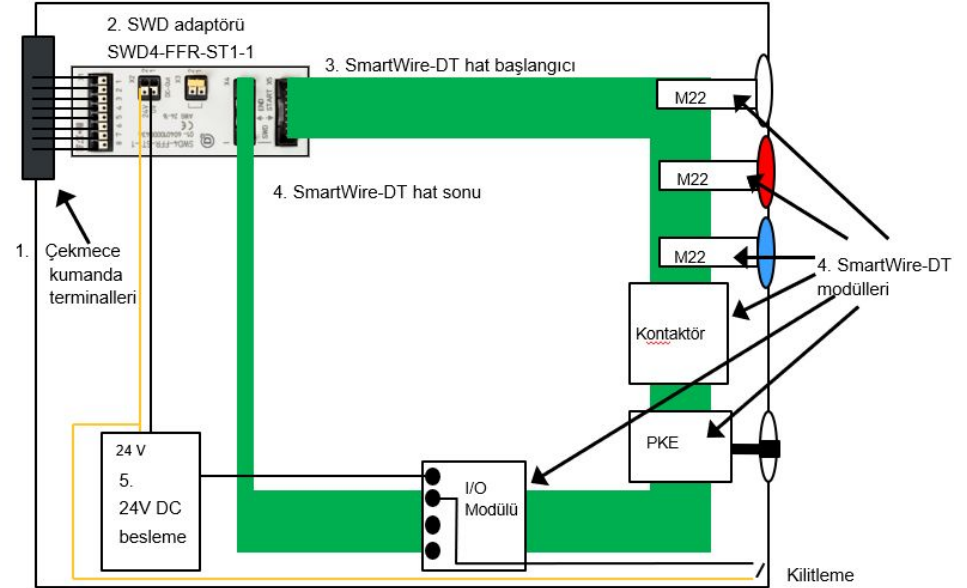
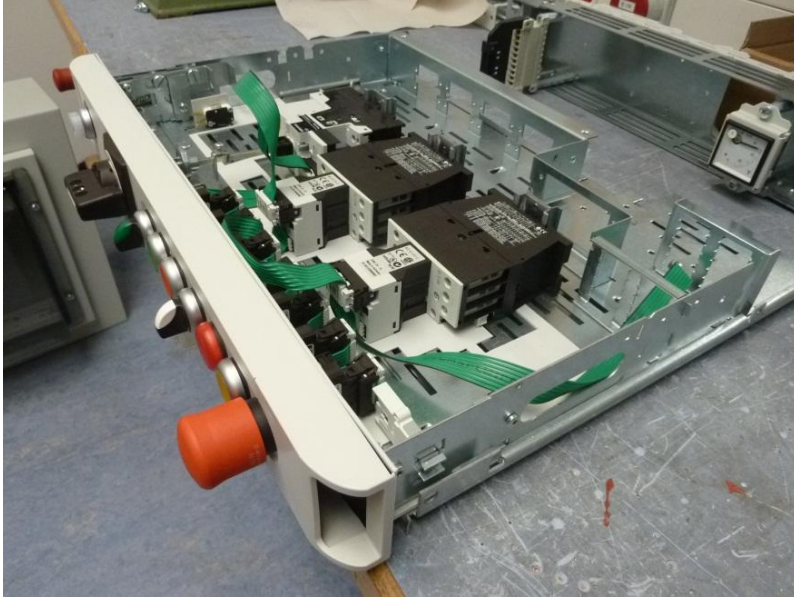

EATON

Powering Business Worldwide